

Pre-Owned



Falcon 900EX

S/N 096

2001



 **DASSAULT
AVIATION**



DASSAULT AVIATION

78, quai Marcel Dassault
Cedex 300
92552 Saint-Cloud Cedex
FRANCE

DASSAULT FALCON JET CORP.

200 Riser Road
Little Ferry, NJ 07643
USA

Falcon 900EX

S/N 096

SPECIFICATIONS



Falcon 900EX S/N 096**ENGINE TYPE**

Honeywell TFE 731-60-1C	on MSP "GOLD"
-------------------------	---------------

#1 Engine S/N P112415

#2 Engine S/N P112414

#3 Engine S/N P112413

APU TYPE

AlliedSignal GTCP36-150(F)	S/N P409	on MSP "GOLD"
----------------------------	----------	---------------

MAINTENANCE

Under CAMP. Next "4C check" and L/G Overhaul due March 2026.

ELITE II OPTIONS

2020 ELITE II Retrofit: ADS-B Out, WAAS LPV, CPDLC ATNB1, FANS-1A, 5 ea. DU-875 LCD and 3 ea. CDU-830

AVIONICS

AP		Honeywell Primus 2000
FMS	Triple	Honeywell FMS 6.1.1 w/ CDU-830
COMM (VHF)	Triple	Collins VHF-422C
NAV (VHF)	Dual	Collins VIR-432
ADF	Dual	Collins ADF-462
DME	Dual	Collins DME-442
ADC	Dual	Honeywell AZ840
XPNDR	Dual	Collins TDR94D
GPS	Dual	Honeywell SBAS (WAAS & EGNOS)
SATCOM		Honeywell MCS 7120 Level D/ Direct Cabin Router Wifi Activated (2.4 GHZ WAP, NO 3G) Falcon Connect
HFCOM	Dual	HF9000
EFIS	Five	DU-875 LCD
RADAR		Honeywell Primus 880
RADIO ALTIMETER		Honeywell AA-300
EGPWS		Honeywell MK V EGPWS with Windshear
TCASS		Collins TCAS II TTR-920 6 .04a 7.0/7 .1
HEAD-UP GUIDANCE SYSTEM		Flight Dynamics HGS-2860

AVIONICS

LRNAV	Triple	Honeywell Laseref IV
CVR		Honeywell 120 mn (980-4710-003)
FDR		Honeywell
AIRSHOW		Airshow 410
ELT		Triband, 406 mHz

ADDITIONAL EQUIPMENT**Entertainment:**

Collins Venue Audio/HD Entertaining System w/ Alto Subwoofers,
Galley 16:9 TS, Blu-Ray Player,
2 ea. 18" HD Bulkhead LCD monitors,
4 ea. 9" HD Plug'in LCD monitors,
8 ea. Rosen receptacles,
Ipod Electronic control module and Docking cradle.

Galley-Aux Galley:

Central Water System,
2 ea. Thermos Carafes, TIA coffee maker,
Microwave, High temp Oven.

Misc:

Flightdeck Video Camera System,
Securaplane 450 Aircraft Security System,
Toshiba Laser Fax/Copier/Printer,
B.F. Goodrich Stormscope Weather Mapping,
EMTEQ LED direct/indirect lighting,
Electronic portable checklist,
115 VAC / 60 Hz (1200VA), Teleflex recognition lights.

SB Applied:

Brake/Wheel Well Heat, Increase MTOW.

EXTERIOR

Complete Paint performed in 2014: White body without any stripes

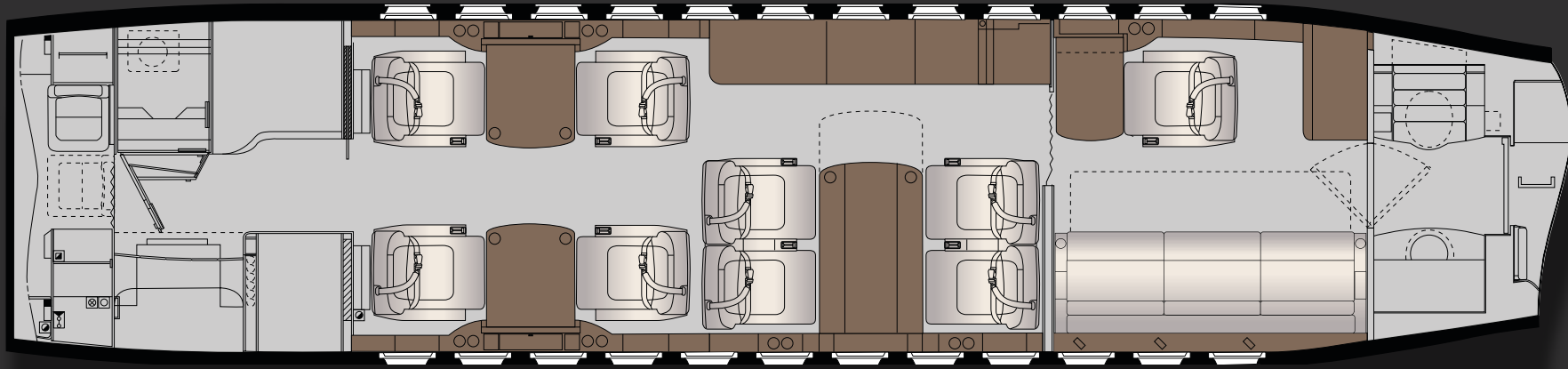

INTERIOR

Cabin Refurb in 2014: Beige leather seats w/ white center insert, brown carpet w/ 100% wool /light silk waded lines, Cherry – Ash - Mahogany wood veneer, Nickel metal plating.

SEATING

12 Pax floor plan w/ 3rd crew seat.

Galley sliding pocket door, FWD and Aft Lavatories

AFT cabin divider w/removable curtain, AFT cabin w/1 Sofa and executive Seat.

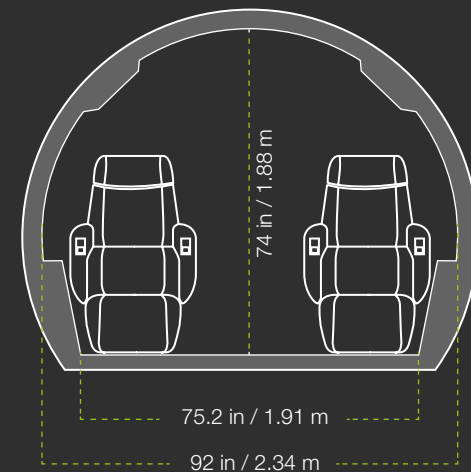

Falcon 900EX

S/N 096

PHOTO GALLERY



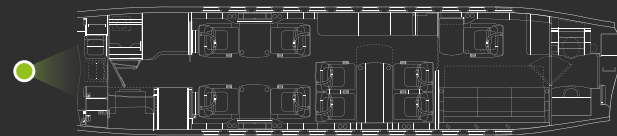

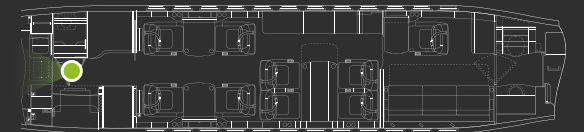

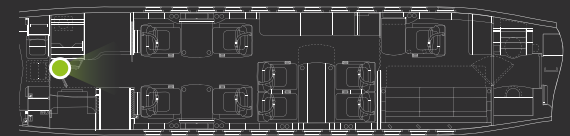

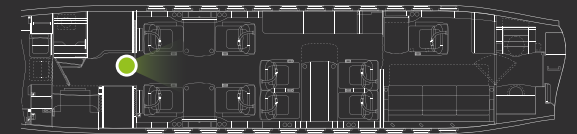

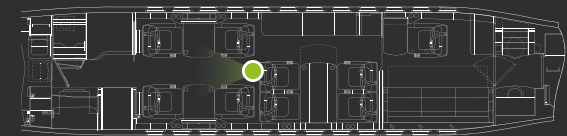

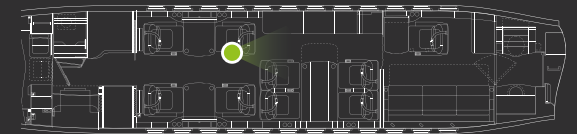

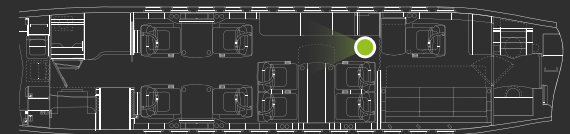

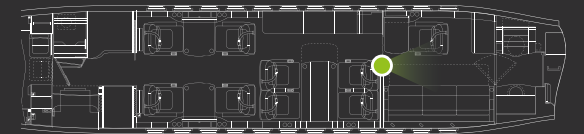

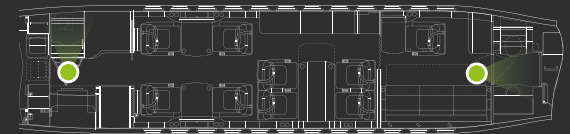

DASSAULT AVIATION

Dominique **CRUCHON**

Director, Pre-Owned Aircraft Sales

78, quai Marcel Dassault

92552 Saint-Cloud Cedex 300

France

Work Phone: + 33 1 47 11 60 71

Fax: + 33 1 47 11 89 17

E-mail: dominique.cruchon@dassault-aviation.com

Yvon **DESIGNES**

Manager, Pre-Owned Aircraft Sales

78, quai Marcel Dassault

92552 Saint-Cloud Cedex 300

France

Work Phone: + 33 1 47 11 61 24

Fax: + 33 1 47 11 89 17

Email: yvon.desvignes@dassault-aviation.com

DASSAULT FALCON JET

Mark **VERDESCO**

Director, Pre-Owned Aircraft Sales

200 Riser Road

Little Ferry, NJ 07643

USA

Work Phone: + 1 201 541 4556

Fax: + 1 201 541 4620

E-mail: mark.verdesco@falconjet.com

Andrew **STARK**

Regional Sales Manager, Pre-Owned Aircraft Sales

200 Riser Road

Little Ferry, NJ 07643

USA

Work Phone: + 1 201 541 4552

Fax: + 1 201 541 4620

Email: andrew.stark@falconjet.com



