

Pre-Owned



Falcon 900EX

S/N 078

2001



 **DASSAULT
AVIATION**



DASSAULT AVIATION

78, quai Marcel Dassault
Cedex 300
92552 Saint-Cloud Cedex
FRANCE

DASSAULT FALCON JET CORP.

200 Riser Road
Little Ferry, NJ 07643
USA

Falcon 900EX

S/N 078

SPECIFICATIONS



Falcon 900EX S/N 078**ENGINE TYPE**

Honeywell TFE731-60-1C	on MSP "GOLD"
------------------------	---------------

#1 Engine S/N P112348

#2 Engine S/N P112346

#3 Engine S/N P112356

APU TYPE

AlliedSignal GTCP36-150	S/N P385	on MSP "GOLD"
-------------------------	----------	---------------

MAINTENANCE

Under CAMP. Next "2C check" and L/G Overhaul due March 2025.

ELITE II OPTIONS

ELITE II (Retrofit 2019): ADS-B Out, WAAS LPV, CPDLC ATNB1, FANS-1A, 5ea. DU-875 LCD and 2ea. CDU-830.

AVIONICS

AP		Honeywell Primus 2000
----	--	-----------------------

FMS	Dual	Honeywell FMS 6.1.1 w/ CDU-830
-----	------	--------------------------------

COMM (VHF)	Dual	Collins VHF-422C
------------	------	------------------

NAV (VHF)	Dual	Collins VIR-432
-----------	------	-----------------

ADF	Dual	Collins ADF-462
-----	------	-----------------

DME	Dual	Collins DME-442
-----	------	-----------------

ADC	Dual	Honeywell AZ840
-----	------	-----------------

XPNDR	Dual	Collins TDR94D
-------	------	----------------

GPS	Dual	Honeywell SBAS (WAAS & EGNOS)
-----	------	-------------------------------

SATCOM		Honeywell MCS 7120 Level D/ Direct Cabin Router Wifi Activated (2.4 GHZ WAP, NO 3G) Falcon Connect
--------	--	---

HFCOM	Dual	HF9000
-------	------	--------

EFIS	Five	DU-875 LCD
------	------	------------

RADAR		Honeywell Primus 880
-------	--	----------------------

RADIO ALTIMETER		Honeywell AA300
-----------------	--	-----------------

EGPWS		Allied Signal with Windshear
-------	--	------------------------------

TCASS		Collins TCAS II TTR-920 6 .04a 7.0/7 .1
-------	--	---

LRNAV	Dual	Honeywell Laseref IV
-------	------	----------------------

AVIONICS

CVR	Honeywell 120 mn (980-6022-011)
FDR	Honeywell
AIRSHOW	Airshow 400
ELT	Triband, 406 mHz

ADDITIONAL EQUIPMENT

Audio-International Multistandard DVD,
1 ea. 18" LCD, 2ea. 8.4" Rosen LCD's (8 ea. Plug'in monitor receptacles),
CD player, Electronic portable checklist,
220 VAC / 50 Hz w/ 9 outlets,
Devorre Reco. Light,
St-By Altimeter.

EXTERIOR

White body without any stripes.

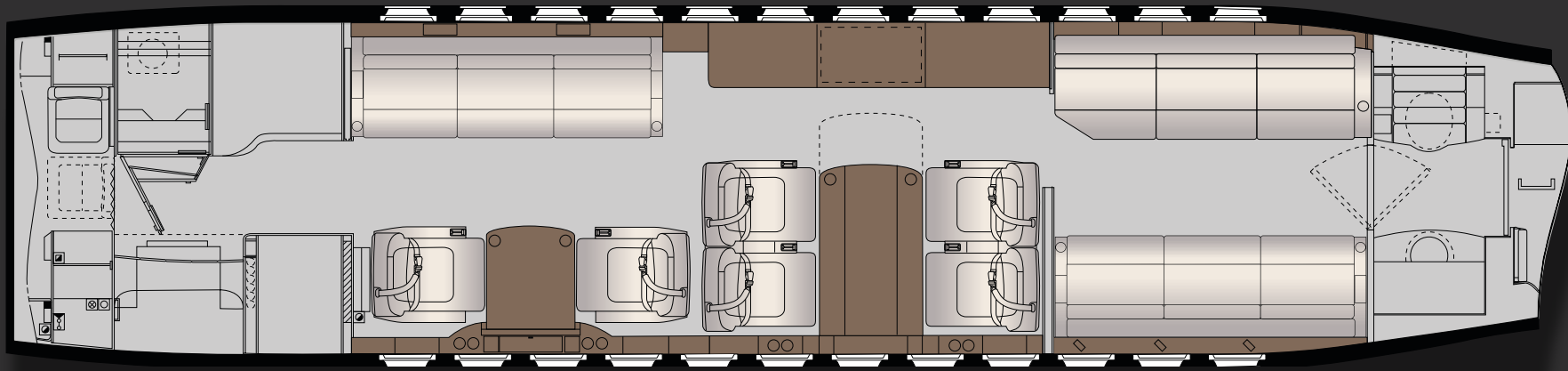

INTERIOR

Beige leather seats and sofas with beige carpet (brand new), Elm Burl wood veneer, Almond Ultrasuede headliner, Satin Nickel metal.

SEATING

15 Pax floor plan w/ 3rd crew seat. Galley sliding pocket door, FWD cabin w/ 2 Seats & 1 Sofa, AFT cabin divider w/ storage curtain, AFT cabin w/ 2 Sofas, FWD & AFT Lavatories.

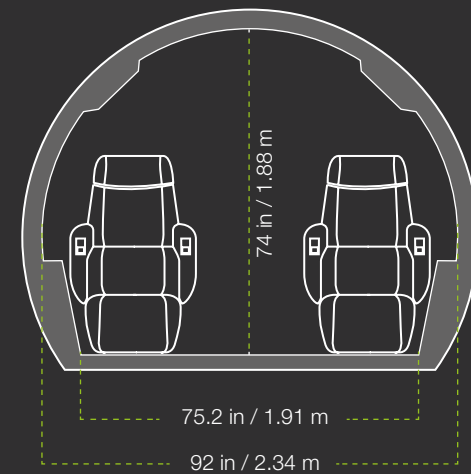

Falcon 900EX

S/N 078

PHOTO GALLERY





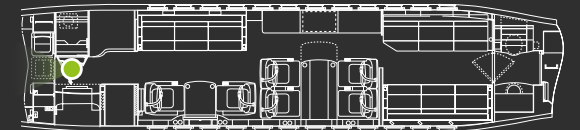



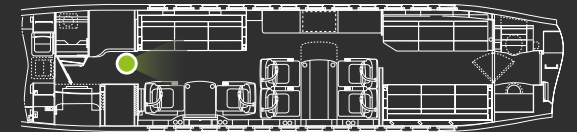

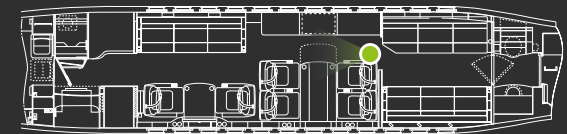

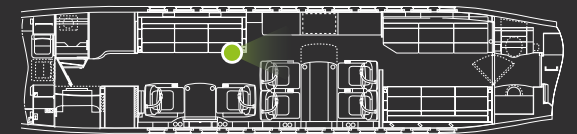

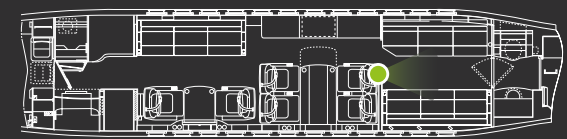

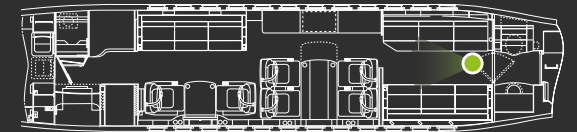

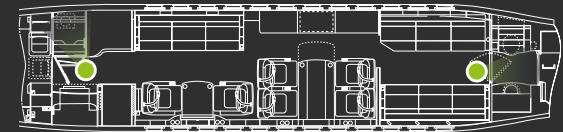

DASSAULT AVIATIONYvon **DESVIGNES**

Director, Pre-Owned Aircraft Sales

78, quai Marcel Dassault

92552 Saint-Cloud Cedex 300

France

Work Phone: + 33 1 47 11 61 24

Mobile: + 33 6 08 16 19 73

E-mail: yvon.desvignes@dassault-aviation.comNicolas **MARTIN**

Manager, Pre-Owned Aircraft Sales

78, quai Marcel Dassault

92552 Saint-Cloud Cedex 300

France

Work Phone: + 33 1 47 11 51 02

Mobile: + 33 6 26 79 50 50

Email: Nicolas.Martin@dassault-aviation.com**DASSAULT FALCON JET**Mark **VERDESCO**

Director, Pre-Owned Aircraft Sales

200 Riser Road

Little Ferry, NJ 07643

USA

Work Phone: + 1 201 541 4556

Fax: + 1 201 541 4620

E-mail: Mark.Verdesco@dassaultfalconjet.com

