

Pre-Owned



# Falcon 900LX

S/N 263

2013



 **DASSAULT  
AVIATION**



**DASSAULT AVIATION**

78, quai Marcel Dassault  
Cedex 300  
92552 Saint-Cloud Cedex  
FRANCE

**DASSAULT FALCON JET CORP.**

200 Riser Road  
Little Ferry, NJ 07643  
USA

# Falcon 900LX

S/N 263

SPECIFICATIONS



**Falcon900LX** S/N 263**ENGINE TYPE**

Honeywell TFE731-60-1C	on MSP "GOLD"
#1 Engine S/N P112991	
#2 Engine S/N P112981	
#3 Engine S/N P112912	

**APU TYPE**

Honeywell GTCP36-150(F)	S/N P620	on MSP "GOLD"
-------------------------	----------	---------------

**MAINTENANCE**

On CAMP. Fresh (March 2026) 12M 800H by DFS, "2C" CW March 2025 by AMAC.

**EASY II OPTIONS**

EASY II 4th Cert, SBAS / LPV, ADS-B out, ADM, SVS, Dual Jeppesen, CPDLC ATN-B1, FANS-1A+, RAAS, Push-to-Load, Fast Charts Dataloading

**AVIONICS**

VHF COMMUNICATION SYSTEMS	Triple	Honeywell TR-866B
HF COMMUNICATION SYSTEMS	Dual	Rockwell Collins HF-9000
FLIGHT DECK AUDIO	Triple	Honeywell AV-900
EMERGENCY LOCATOR TRANSMITTER		Elta ADT-406 (TRI-BAND) w/ NAV Interface
FLIGHT DECK PRINTER		Miltope TP-4840 (for AFIS, Maintenance Jeppesen Charts)
SATCOM SYSTEM		Honeywell MCS-7120 (SBB INTERNET) WIFI
VOR/ILS/MARKER NAVIGATION SYSTEM	Dual	Honeywell NV-875B
ADF SYSTEMS	Dual	Honeywell DF-855
GLOBAL POSITIONING SYSTEM	Dual	Honeywell (SBAS capable)
FLIGHT MANAGEMENT SYSTEM	Triple	Honeywell EASY
ELECTRONIC JEPPESEN CHARTS	Dual	Honeywell
COLOR WEATHER RADAR SYSTEM		Honeywell PRIMUS 880
DME SYSTEMS	Dual	Honeywell DM-855
ATC, TRANSPONDER	Dual	Honeywell XS-857A MODE S
RADIO ALTIMETER SYSTEM		Honeywell RT-300
TCAS II SYSTEM		ACSS TCAS-3000 (TCAS 7.1)
MODULAR AVIONICS UNIT	Dual	Honeywell EASY MAU-920
HEAD-UP GUIDANCE SYSTEM		Rockwell Collins HGS-4860
ENHANCED VISION SYSTEM (EVS)		Rockwell Collins EFVS-4860

**AVIONICS**

MICRO INERTIAL REFERENCE SYSTEM	Dual	Honeywell LASEREF V
COCKPIT VOICE RECORDER		Honeywell SSCVR (2 Hrs)
FLIGHT DATA RECORDER		Honeywell SSFDR 88 Parameters w/ QAR
EGPWS		Honeywell EASY

**ADDITIONAL EQUIPMENT****Rockwell Collins HD Entertainment:**

3D Interactive MAP,  
 1ea. 10.6" Touch Screen Control monitor,  
 Dual Blue Ray player,  
 2ea. 22" HD Bulkhead monitors,  
 4ea. 10.6" Plug'in monitors w/ 8ea. receptacles,  
 iPod/iPad remote controls, PC Video VGA Interface + HDMI,  
 AoD and AVoD USB Ports.

**Misc:**

Selcal, CMF, Uplink Weather capability,  
 Flight Deck Video Interface,  
 Meggitt MK2 Secondary Flight Display,  
 Enlarged oxygen bottle (115 Cu. Ft.),  
 3rd EROS oxygen mask & pilot full face masks w/ removable goggle,  
 115 VAC/60hz/2000VA w/ 11 outlets,  
 2ea. 12 man life rafts, main batteries charging with GPU,  
 Additional Smoke Hood "Crew Type",  
 Telescopic Tow Bar.

**Galley:**

Central Water System,  
 De Longhi Nespresso coffee maker,  
 Xtra wide high temp Oven,  
 Microwave oven.

**Significant SB applied:**

Increased MTOW,  
 Brake/Wheel Well Heat,

**EXTERIOR**

Overall White with Red and Grey curved waved stripes on fuselage and fin.

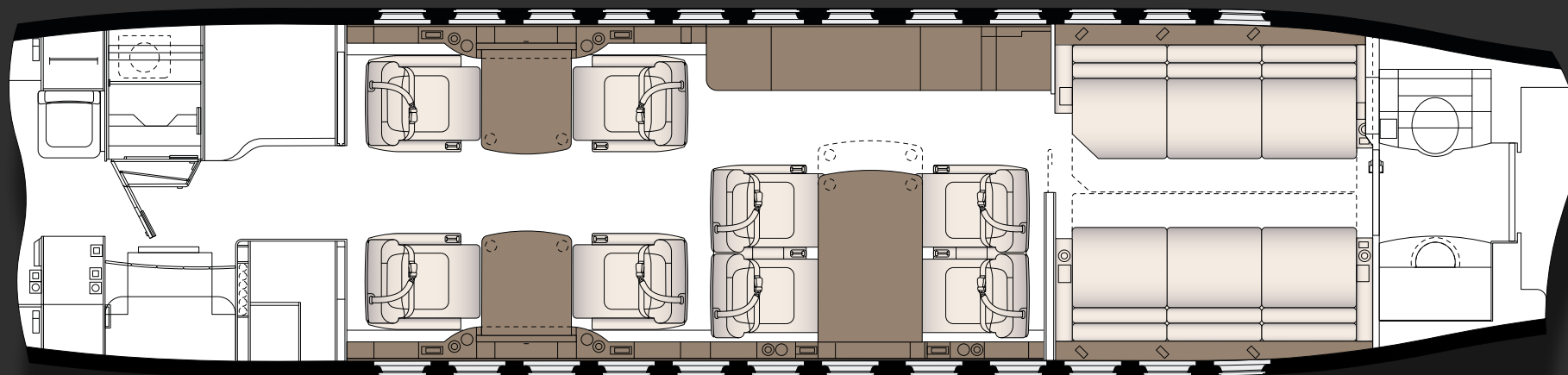

### INTERIOR

Beige leather seats w/ brown insert, Beige fabric sofas, Beige carpet (installed in march 2025), QTR Composite Ebony wood veneer, Rose Gold Satin Metal plating.

### SEATING

14 Pax floor plan w/ 3rd crew seat.

FWD & AFT lavatories, Galley pocket door,

AFT solid partition w/ electric roller Curtain,

2 Divans (10" Berth Manual & Electrical Ctrld)

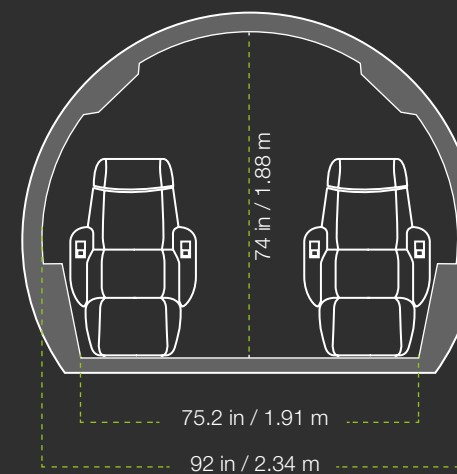

# Falcon 900LX

S/N 263  
PHOTO GALLERY



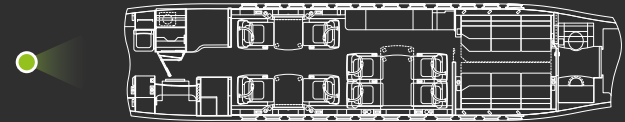

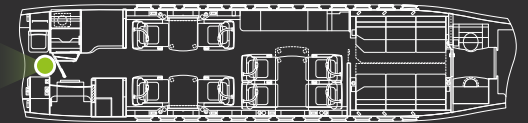

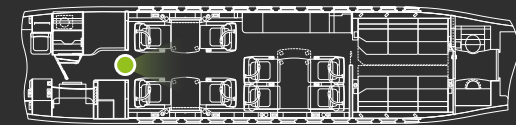

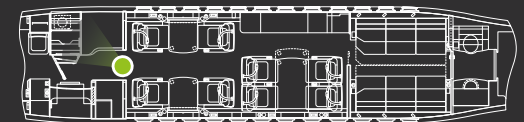

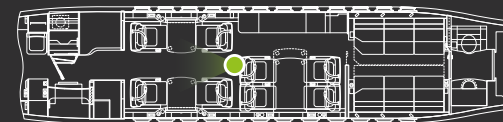

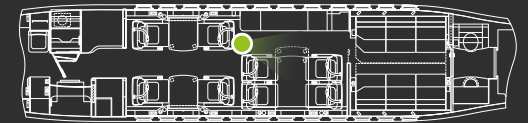

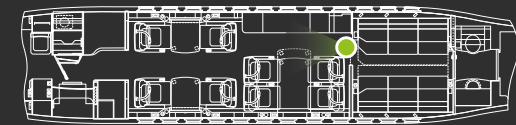

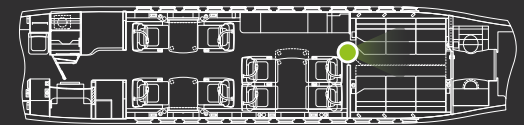

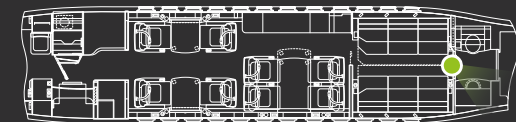



**DASSAULT AVIATION**Yvon **DESVIGNES**

Director, Pre-Owned Aircraft Sales

78, quai Marcel Dassault

92552 Saint-Cloud Cedex 300

France

Work Phone: + 33 1 47 11 61 24

Mobile: + 33 6 08 16 19 73

E-mail: [yvon.desvignes@dassault-aviation.com](mailto:yvon.desvignes@dassault-aviation.com)Nicolas **MARTIN**

Manager, Pre-Owned Aircraft Sales

78, quai Marcel Dassault

92552 Saint-Cloud Cedex 300

France

Work Phone: + 33 1 47 11 51 02

Mobile: + 33 6 26 79 50 50

Email: [Nicolas.Martin@dassault-aviation.com](mailto:Nicolas.Martin@dassault-aviation.com)**DASSAULT FALCON JET**Mark **VERDESCO**

Director, Pre-Owned Aircraft Sales

200 Riser Road

Little Ferry, NJ 07643

USA

Work Phone: + 1 201 541 4556

Fax: + 1 201 541 4620

E-mail: [Mark.Verdesco@dassaultfalconjet.com](mailto:Mark.Verdesco@dassaultfalconjet.com)



