

Pre-Owned



# Falcon 2000LX

S/N 230  
2012



 **DASSAULT  
AVIATION**



**DASSAULT AVIATION**

78, quai Marcel Dassault  
Cedex 300  
92552 Saint-Cloud Cedex  
FRANCE

**DASSAULT FALCON JET CORP.**

200 Riser Road  
Little Ferry, NJ 07643  
USA

# Falcon 2000LX

S/N 230

SPECIFICATIONS



**Falcon2000LX** S/N 230 - 2012**ENGINE TYPE**

PW 308C	covered by JSSI 100%
#1 Engine: PCE-CF0493	
#2 Engine: PCE-CF0279	Rental engine: original Engine PCE-CF0488 to be reinstalled after ongoing HSI

**APU TYPE**

GTCP36-150 (F2M)	S/N P595	covered by JSSI 100%
------------------	----------	----------------------

**MAINTENANCE**

Under CAMP. Next "3C check" due in February 2030
--

**EASy OPTIONS**

EASy II (4th cert), ADS-B Out, SBAS-LPV, SVS, CPDLC ATN-B1, FANS 1/A+
---

**AVIONICS**

<b>Honeywell Primus Epic System (EASy II, 4th Cert)</b>		
VHF COMMUNICATION SYSTEMS	Triple	Honeywell TR-866B
HF COM	Dual	Collins HF 9000 W/ SELCAL
FLIGHT DECK AUDIO	Triple	Honeywell AV-900
EMERGENCY LOCATOR TRANSMITTER		Elta ADT-406 w/ NAV Interface
SATCOM SYSTEM	Dual	Iridium Aircell Axess II + Aviator 300 (wifi in cabin)
COMMUNICATION MANAGT FUNCTION		EASy/AFIS/SATAFIS & MILTOPE Flight Deck Printer
VOR/ILS/MARKER NAVIGATION SYSTEM	Dual	Honeywell NV-875B
ADF SYSTEM	Dual	Honeywell DF 855
GPS	Dual	Honeywell
FLIGHT MANAGEMENT SYSTEM	Triple	Honeywell
ELECTRONIC JEPPESEN CHARTS		Honeywell EASy
COLOR WEATHER RADAR SYSTEM		Honeywell Primus 880
DME SYSTEM	Dual	Honeywell DM-855
AIR TRAFFIC CONTROLLER	Dual	Honeywell XS-857A (Mode S)
RADAR ALTIMETER SYSTEM		Honeywell RT-300
TCAS II SYSTEM		ACSS TCAS-3000 (TCAS 7.1)
HEAD UP GUIDANCE SYSTEM		HGS-4860
ENHANCED VISION SYSTEM		EFVS-4860

**AVIONICS**

MICRO INERTIAL REFERENCE SYSTEM	Triple	Honeywell Laseref V
COCKPIT VOICE RECORDER		Honeywell SSCVR (120 MINUTES)
FLIGHT DATA RECORDER		Honeywell SSFDR
EGPWS		Honeywell EASy

**ADDITIONAL EQUIPMENT****Entertainment:**

Rockwell Collins FCMS system,  
 Dual Blu-Ray player,  
 I Pod interface with i-Pod remote control,  
 2ea. 22" HD LCD monitors,  
 4ea. Rockwell 10.6" LCD plug-in monitors with 6ea. Receptacles

**Galley:**

1 ea. Hot Cup,  
 ea. Iacobucci Nespresso Coffee Machine,  
 1 ea. Xtra wide High Temp Oven, 1 ea. Microwave,  
 115VAC 60HZ 2000VA Inverter with 8 outlets.

**Emergency:**

2 ea. 8-man Life Rafts,  
 3 EROS Full face O<sup>2</sup> masks,  
 115Cu Ft enlarged O<sup>2</sup> bottle.

**Lights:**

2 vertical fin Teleflex recognition lights,  
 EMTEQ LED direct/indirect lighting.

**Misc:**

Telescoping tow bar,  
 Secondary Flight Display,  
 Main Batteries Charging w/ GPU.

**SB:**

Brake/Wheel Well Heat,  
 Increased MTOW.

**EXTERIOR**

Overall White with Red and Grey waved stripes on fuselage and fin.

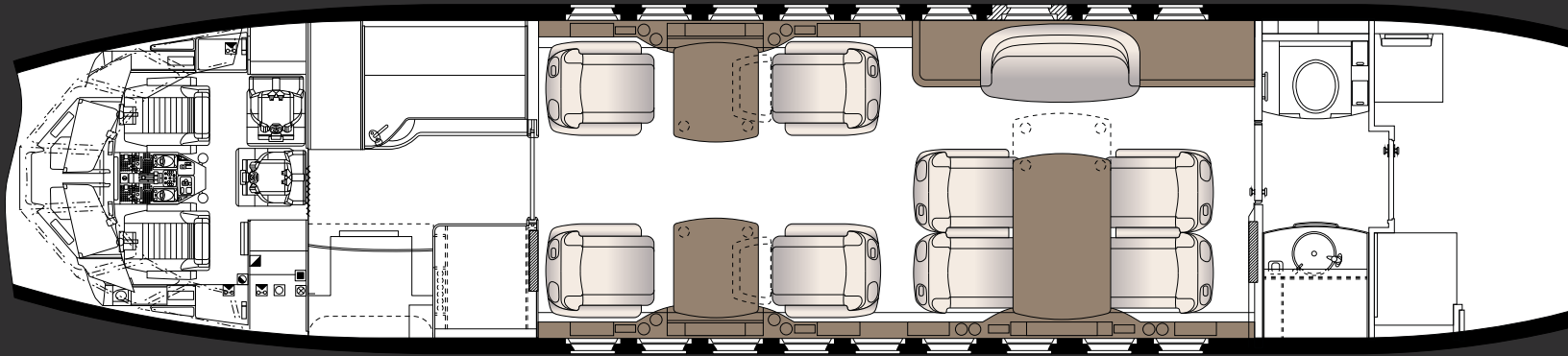

### INTERIOR

Almond beige harmony. Edelman Royal Hide "CLAY" and "Brown" dual color leather seats, "Tabu/Newood" wood veneer. Satin black nickel metal plating. New Carpet installed in 2024. Hi-Gloss Marbled Etimoe wood veneer and Satin Champagne Gold metal plating.

### SEATING

8 Pax floor plan w/3rd crew seat.  
Galley pocket sliding door, Fwd 4 Club Seats,  
Dining group, Credenza w/ Settee, Aft Lavatory.

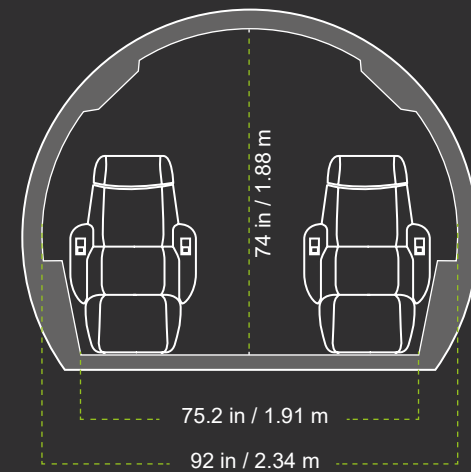

# Falcon 2000LX

S/N 230

PHOTO GALLERY





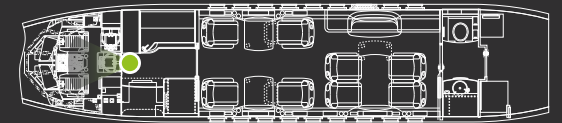

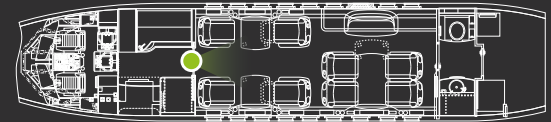

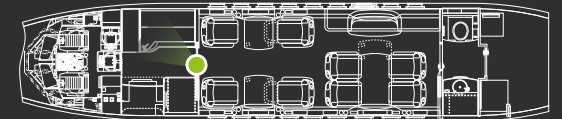

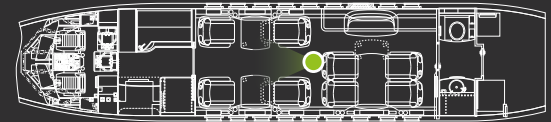

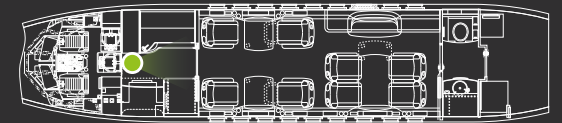



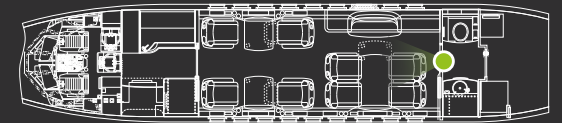

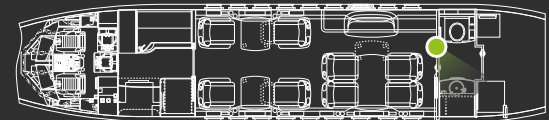



**DASSAULT AVIATION****Yvon DESVIGNES**

Director, Pre-Owned Aircraft Sales

78, quai Marcel Dassault

92552 Saint-Cloud Cedex 300

France

Work Phone: + 33 1 47 11 61 24

Mobile: + 33 6 08 16 19 73

E-mail: [yvon.desvignes@dassault-aviation.com](mailto:yvon.desvignes@dassault-aviation.com)

**Nicolas MARTIN**

Manager, Pre-Owned Aircraft Sales

78, quai Marcel Dassault

92552 Saint-Cloud Cedex 300

France

Work Phone: + 33 1 47 11 51 02

Mobile: + 33 6 26 79 50 50

Email: [Nicolas.Martin@dassault-aviation.com](mailto:Nicolas.Martin@dassault-aviation.com)

**DASSAULT FALCON JET****Mark VERDESCO**

Director, Pre-Owned Aircraft Sales

200 Riser Road

Little Ferry, NJ 07643

USA

Work Phone: + 1 201 541 4556

Fax: + 1 201 541 4620

E-mail: [Mark.Verdesco@dassaultfalconjet.com](mailto:Mark.Verdesco@dassaultfalconjet.com)

